

GENERAL INTRODUCTION TO B&G NETWORK

The B&G Network range of instruments has been designed to be used as individual units or connected together to form an integrated navigational system. A single network cable is used to carry data and power between units. The latest technology and screened cables throughout the Network System ensure the ultimate protection from interference between units and other systems. All Network instruments can be linked to Network PILOT, Network CHART, Network GPS or Network LORAN receivers or via NMEA 0183 (v1.5) to other navigational equipment.

INSTRUMENTS

Network SPEED
Network DEPTH
Network QUAD
Network WIND
Network TACK
Network DATA

NAVIGATIONAL AIDS

Network GPS
Network LORAN
Network NAV
Network CHART

AUTOPILOTS

Network PILOT

COMMUNICATIONS

Network VHF

INTRODUCTION TO NETWORK SPEED

The Network SPEED unit measures and displays Speed, Log, Timer and Sea Temperature information on a large back-lit Liquid Crystal Display (LCD). The five keys allow selection of the displayed information and setting of the units mode, calibration factors and operating parameters.

It can operate as the main Network SPEED unit either alone or as part of an Integrated Network Instrument System taking inputs directly from a Speed Sensor which plugs into the socket at the rear of the display, or as a repeater of speed information received via the two Network cable tails.

The Network SPEED unit has no alarm functions, however it has an internal alarm buzzer that will sound when an alarm condition is met on Network Depth, Network QUAD or Network PILOT unit or to indicate a fault condition.

The unit is able to transmit NMEA 0183 (v1.5) data via the system network cables to other Network units and connect to an NMEA device e.g. a position fixer, with a special NMEA output cable.

IMPORTANT NOTE

Your Network SPEED unit must be setup and calibrated correctly before it is used as part of a navigational system.

NETWORK SPEED DISPLAY UNIT



EXAMPLES SYSTEMS USING NETWORK SPEED

Only one Network SPEED unit should have a speed sensor connected to it and set to transducer mode. Up to three more Network SPEED units can be connected on to the system network, these must be set to repeater mode. See SELECTING THE DISPLAY MODE.

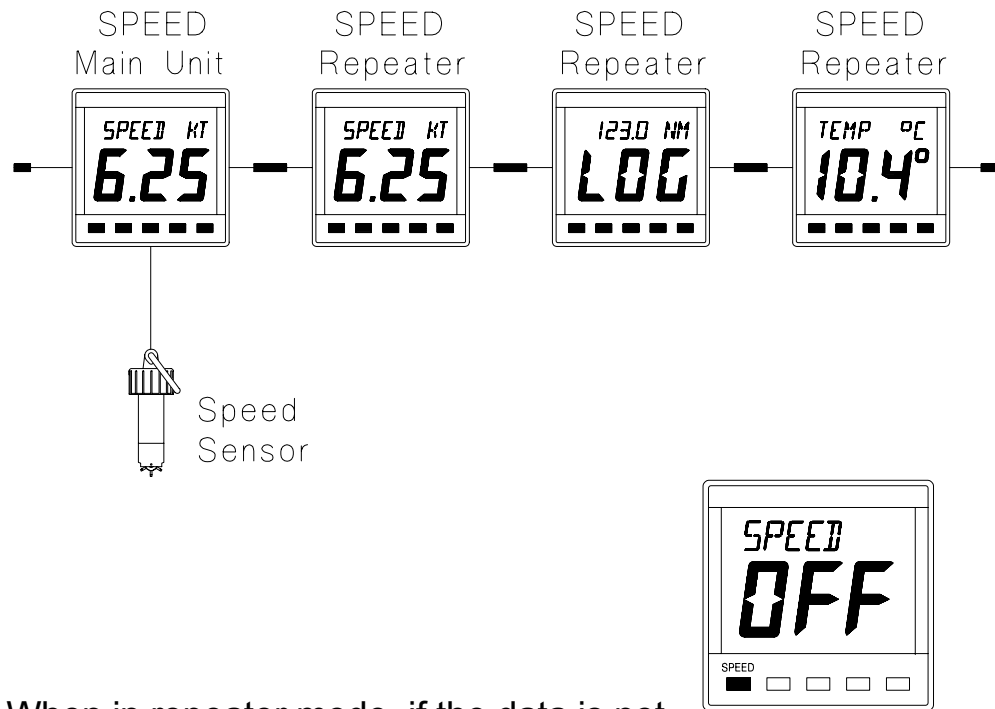

When in repeater mode, if the data is not being received from the system network, the display will show **OFF** when a key is pressed.

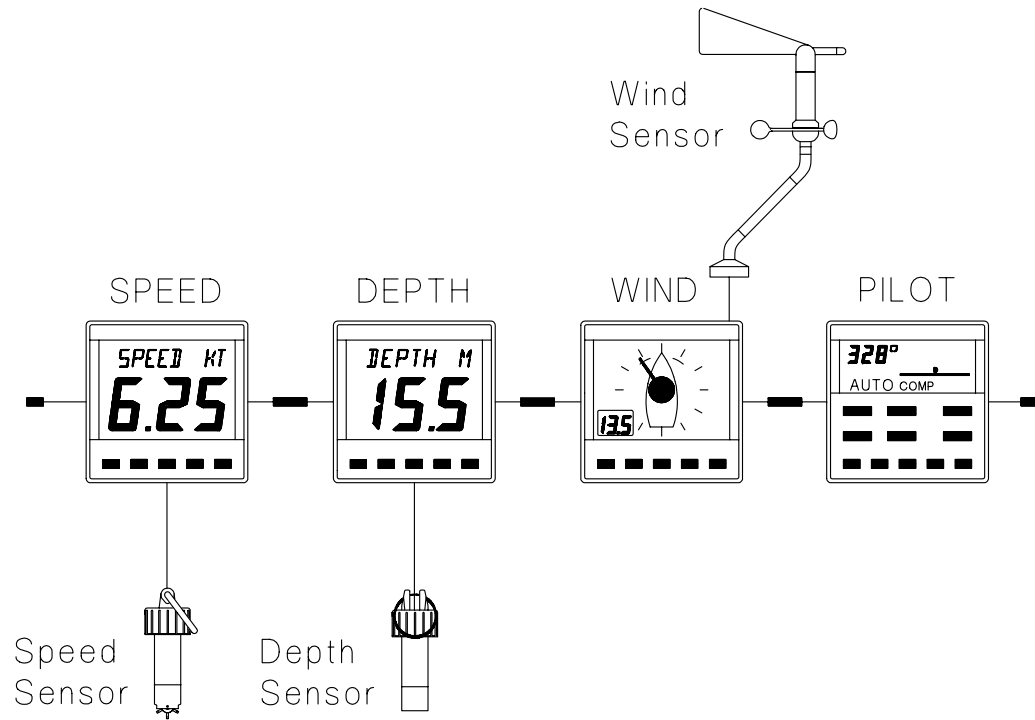

SELECTING THE DISPLAY MODE

The Network SPEED unit has three operating modes. The correct mode must be selected for your Network system to operate properly.

- trA** Transducer mode, the unit uses and displays speed data from a speed sensor connected directly into the display unit.
- rEP** Repeater mode, the unit operates as a speed repeater using data from the system network.
- d** Demo mode, the unit runs an internal demonstration program.

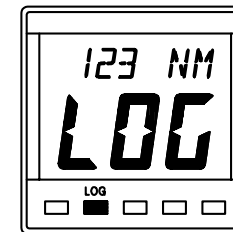
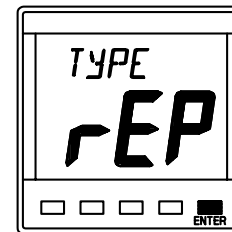
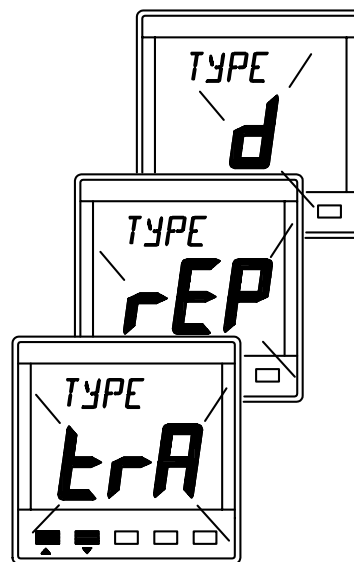
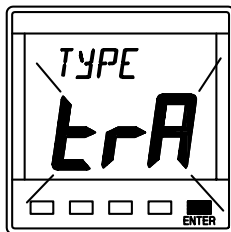
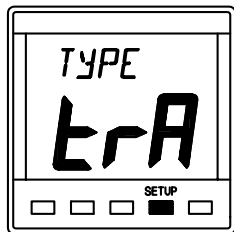
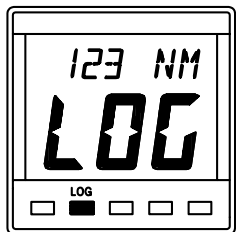

Press **LOG** key to display stored log.

Press **SETUP** key to display the current mode.

Press **ENTER** key if the mode needs to be changed.

Use **▲** or **▼** to change mode.

Press **ENTER** to store the new mode in memory.

Press **LOG** to complete the change.

USING THE SPEED KEY

Press the **SPEED** key to cycle through the following options:

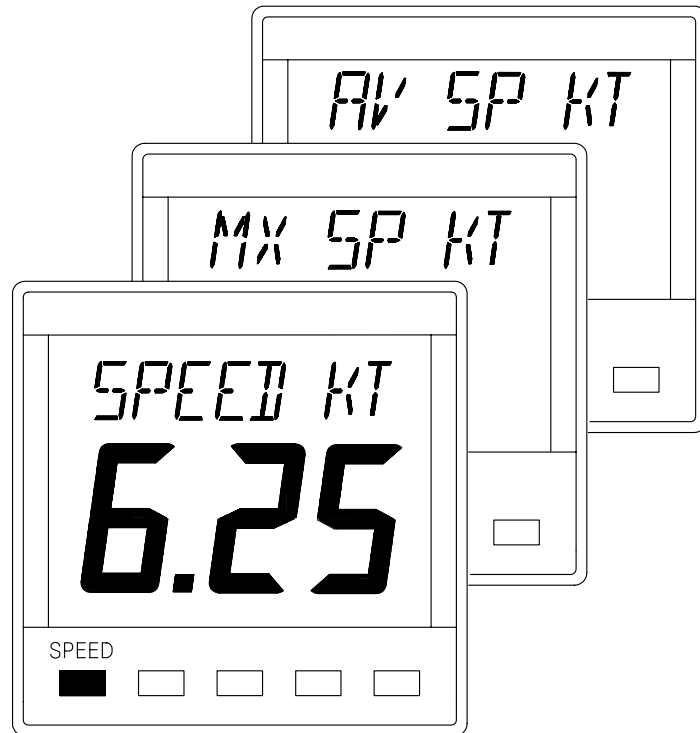

- **SPEED KT** Current boat speed in Knots **KT**, can also be displayed in MPH **MH**.
- **MX SP KT** Maximum boat speed since the last reset of the trip log.
- **AV SP KT** Average boat speed since the last reset of the trip log.

CALIBRATION AND OPERATING PARAMETERS

When current boat speed is displayed, press the **SETUP** key to cycle through the following options:

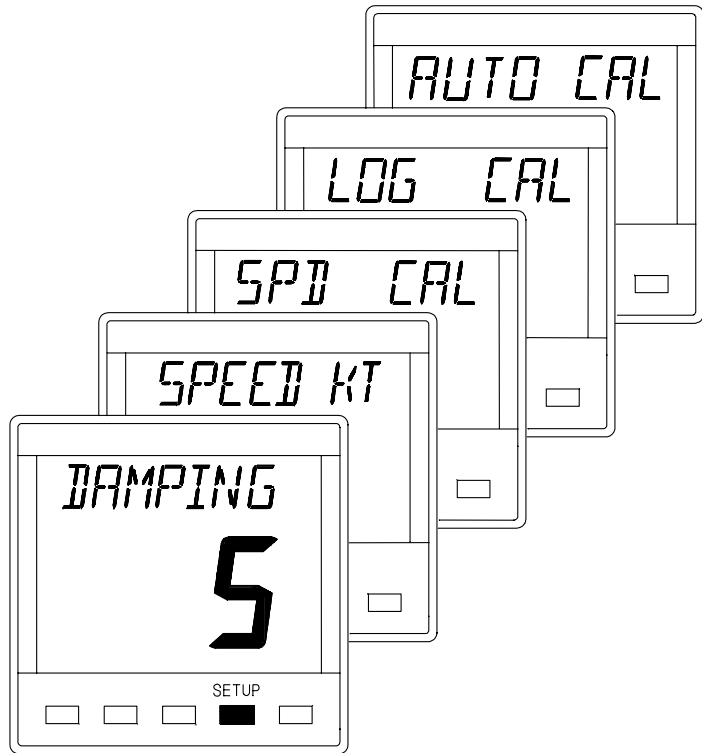

When in **SETUP** mode:

- The **SPEED** key becomes the UP key ▲
- The **LOG** key becomes the DOWN key ▼
- The **LIGHTS** key becomes the **ENTER** key.

- **DAMPING** The response time of the display to changes in boat speed.
- **SPEED KT** The boat speed can be displayed in Knots **KT** or MPH **MH**. This setting also changes the log units to Nautical Miles or Statute Miles.
- **SPD CAL** Manual boat speed and log calibration
- **LOG CAL** Manual boat speed and log calibration
- **AUTO CAL** Automatic boat speed and log calibration

The procedures for using the **SETUP** options are on the following pages.

SETTING THE DISPLAY DAMPING

Damping allows the response time of the displayed speed value to be slowed down if it is too jumpy in rough weather, or to speed it up when the conditions are calm. The damping works by averaging the values over a set time period; the longer the time period the smoother the readings, however the longer it takes to see a change. Similarly the shorter it is the jumpier the readings, but the faster the response.

The Network SPEED unit has a factory set value of 5, this can be adjusted in the range 1 to 64, each step is approximately one second.

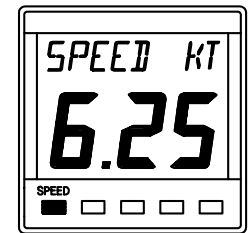
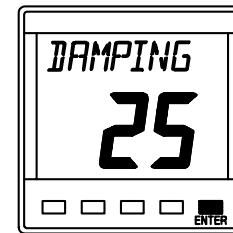
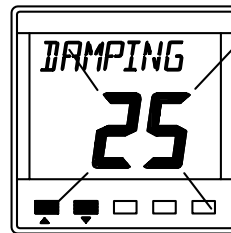
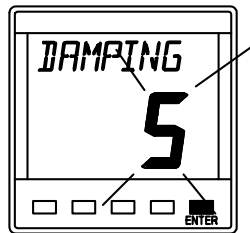
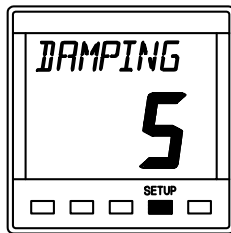
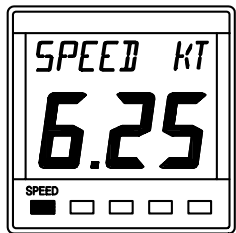

Press **SPEED** key to display current boat speed.

Press **SETUP** key twice to display damping value.

Press **ENTER** key if the value is to be changed.

Use ▲ or ▼ to change the value.

Press **ENTER** key to memorise the change.

Press **SPEED** key to display current boat speed.

SETTING THE SPEED AND LOG UNITS

The Network SPEED can be set to display boat speed in Knots **KT** or MPH **MH**.

If boat speed is in Knots then log is in Nautical Miles **NM**.

If boat speed is in MPH then log is in Statute Miles **M**.

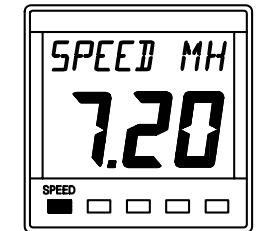
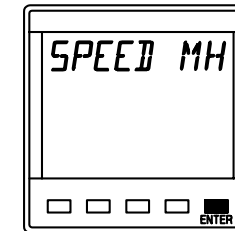
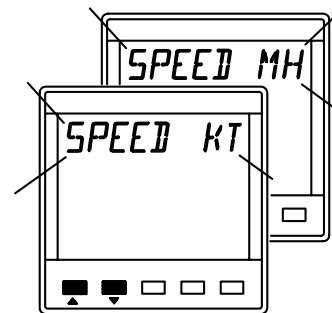
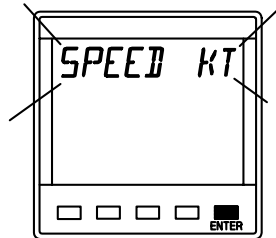
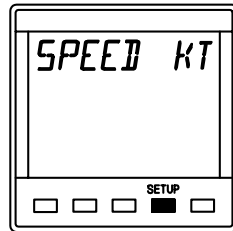
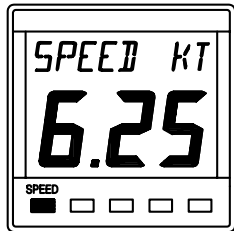

Press **SPEED** key to display current boat speed.

Press **SETUP** key twice. The speed display will blank.

Press **ENTER** key if the units are to be changed.

Use **▲** or **▼** to change the units.

Press **ENTER** key to memorise the change.

Press **SPEED** key to display current boat speed.

SPEED AND LOG CALIBRATION

Before Network SPEED is used for navigation the boat speed and log have to be calibrated to ensure accuracy for your installation and the boats hull characteristics.

Three methods are available with the Network SPEED unit, two manual adjustments and one automatic:

MANUAL CALIBRATION

- 1 SPEED** The displayed boat speed value is corrected manually to read a known measured speed.

- 2 LOG CAL** The units calibration figure (Hz/Knot) is manually adjusted to correct log and speed inaccuracy.

AUTOMATIC CALIBRATION

- 3 AUTO CAL** The unit automatically calibrates and corrects the boat speed and log.

Use the one of the methods overleaf to calibrate your instrument. It is recommended that **AUTO CAL** is used as this method will ensure the most accurate calibration of your Network SPEED unit.

1 - MANUAL CALIBRATION - SPD CAL

This procedure requires a reference boat speed with which to compare the Network SPEED units displayed boat speed. For example, another boat with an accurate calibrated log, or if the top speed of the boat is known this value can be entered during a sea trial to correct the displayed value.

NOTE: The accuracy of this method is dependant upon the accuracy of the reference boat speed.

The example below shows a displayed boat speed of 7.25 knots, the boat speed is known to be 10.0 knots. The displayed value is adjusted to read 10.0 knots.

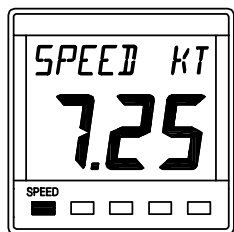

Press **SPEED** key to display current boat speed.



Press **SETUP** key three times to display **SPD CAL**.

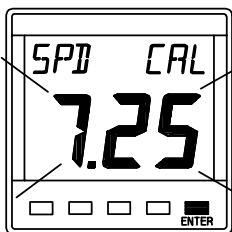

Press **ENTER** key to adjust the displayed value.

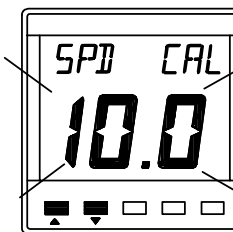

Use **▲** or **▼** to change the value.

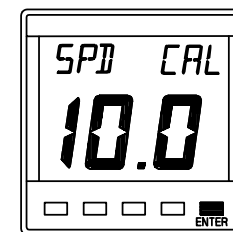

Press **ENTER** to store the new value in memory.

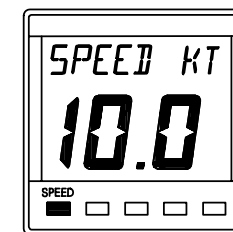

Press **SPEED** key to complete the change.

IMPORTANT NOTE: This method of calibration must not be carried out at boat speeds of **LESS THAN 3 KNOTS** as inaccurate values can be entered into the unit's memory. If the speed/log are not functioning correctly enter a calibration value of 5.3 to 6.2 and then repeat the procedure.

2 - MANUAL CALIBRATION - LOG CAL

If the log or boat speed is in error by a known percentage then this method allows the calibration figure or **LOG CAL** to be adjusted by that amount. The calibration figure is measured in Hertz per knot (Hz/kt), the factory set value is 6.25.

NOTE: The accuracy of this method is dependant upon the accuracy of the calculated percentage error.

Using the factory set **LOG CAL** of 6.25 Hz/kt:

- If the display is under reading by 10% subtract 0.62
- If the display is over reading by 10% add 0.62

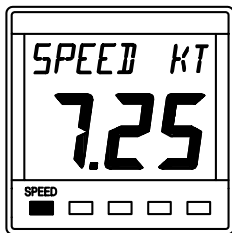

Press **SPEED** key to display current boat speed.

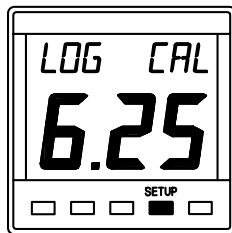

Press **SETUP** key four times to display **LOG CAL**.

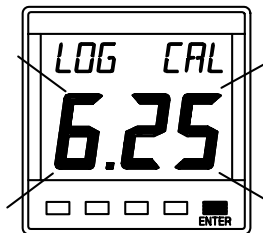

Press **ENTER** key to adjust the displayed value.

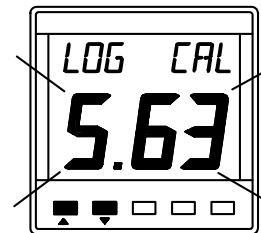

Use \blacktriangle or \blacktriangledown to change the value.

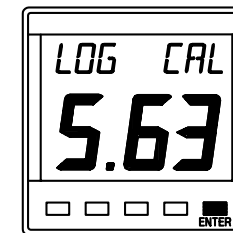

Press **ENTER** to store the new value in memory.

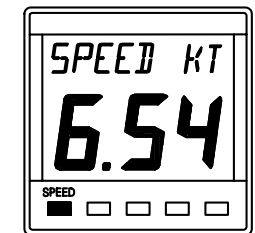

Press **SPEED** key to complete change.

3 - AUTOMATIC CALIBRATION - AUTO CAL

This procedure will automatically and accurately calibrate the boat speed and log and is the recommended method for most boats.

NOTE: **AUTO CAL** can be aborted any time by pressing the **SETUP** key, then the **SPEED** key.

- Select two markers that are easily identifiable on the ground and on a chart, choose a place where the current is at a minimum. Measure and record the distance between the markers on the chart.
- It is recommended that three runs are carried out, this accounts for tidal efforts, and improves accuracy. However a time should be selected when the current is at a minimum, ie slack water between tides.

IMPORTANT NOTE: *The total distance accumulated over the three runs must exceed 0.16 Nautical Miles or 100 metres per run. If this is not achieved the AUTO CAL will fail and the procedure will have to be repeated.*

- Press the **SPEED** key to select current boat speed.
- Press the **SETUP** key five times to display **AUTO CAL**.
- Press the **ENTER** key when in line with marker A, to start run 1. The display will flash **AUTO C 1**. Press **ENTER** key again when in line with marker B, to freeze run 1. The display will flash, showing the distance so far for

one run.

- Turn the boat around for run 2 in the opposite direction over the same measured distance.

Press the **ENTER** key when in line with marker B, to start run 2. The display will flash **AUTO C 2**.

Press **ENTER** key again when in line with marker A, to freeze run 2. The display will flash the accumulated distance so far for two runs.

- Turn the boat around for run 3 (final run) in the opposite direction over the same measured distance.

Press the **ENTER** key when in line with marker A, to start run 3. The display will flash **AUTO C 3**.

Press **ENTER** key again when in line with marker B, to freeze run 3. The display will flash the accumulated distance for three runs.

- Multiply the recorded distance from the chart by the number of runs completed. This is the true distance travelled.
- Adjust the flashing display with the **▲** and **▼** keys until it is the same as the true distance.
- Press the **ENTER** key to complete the calibration. The display will zero, and the calibration is memorised.

AUTOMATIC CALIBRATION PROCEDURE

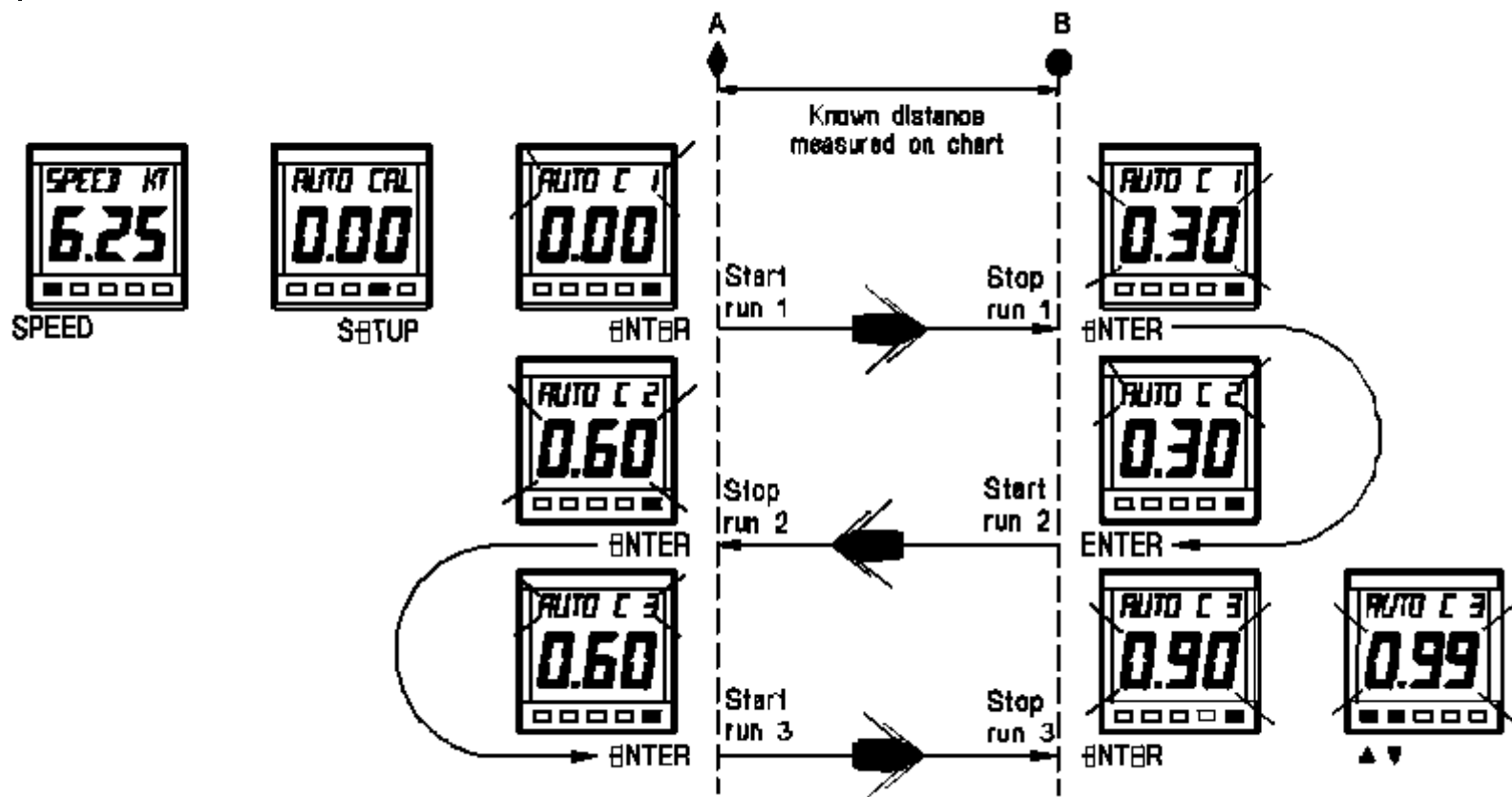

ABORTING AUTO CAL

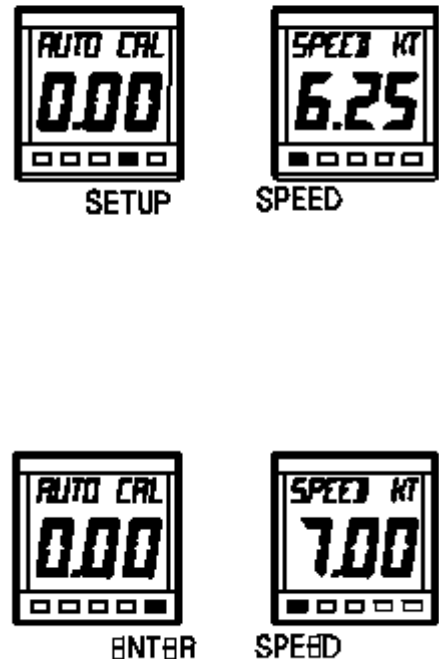

USING THE LOG KEY

Press the **LOG** key to cycle through the following options:

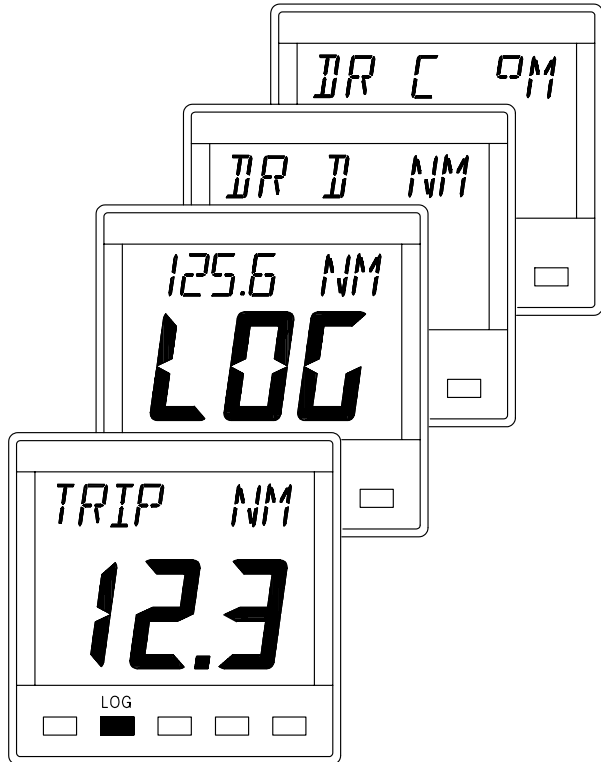

- **TRIP NM** Trip Log, resettable log that can be displayed in Nautical Miles **NM** or Statute Miles **M**. This is determined by the selection of the displayed speed units (see **SETTING THE SPEED AND LOG UNITS**). It also resets the Maximum and Average Speed values.
- **LOG** The Stored Log, in NM or M as above.
- **DR D NM** Dead Reckoned Distance, in NM or M as above. This is a resettable value to be used in conjunction with **DR C °M**.
- **DR C °M** Dead Reckoned Course, in degrees magnetic. For this function to be used Heading must be supplied via the system network from the Network PILOT.

RESETTING THE TRIP LOG

The Trip Log is reset to zero and starts again as soon as the **ENTER** key is pressed.

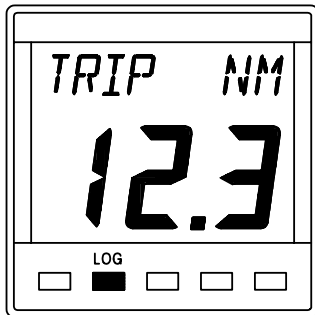

Press **LOG** key to display **TRIP NM**.

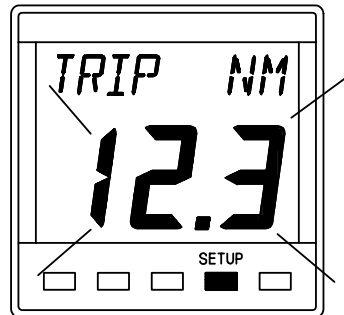

Press **SETUP** key, Display flashes.

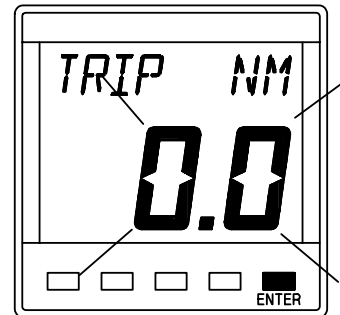

Press **ENTER** key, the display zeros.

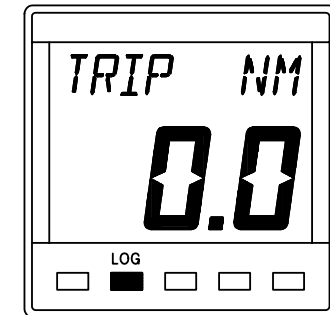

Press **LOG** to display **TRIP NM**.

RESETTING THE DEAD RECKONED DISTANCE

The Dead Reckoned Distance is reset to zero and starts again as soon as the **ENTER** key is pressed.

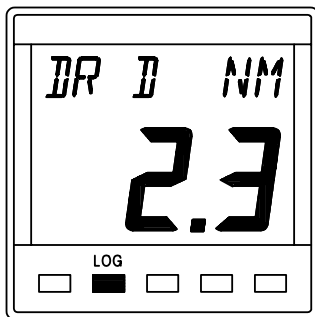

Press **LOG** key to display **DR D NM**.

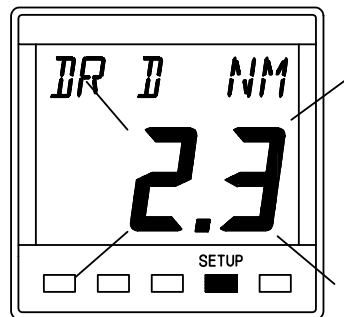

Press **SETUP** key, Display flashes.

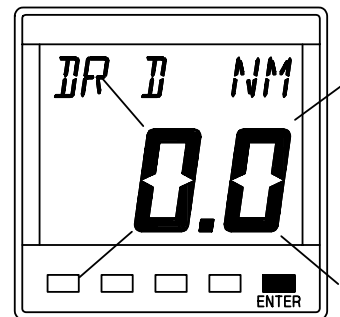

Press **ENTER** key, the display zeros.

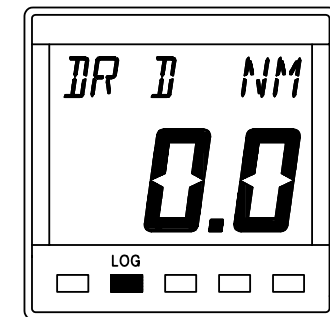

Press **LOG** to display **DR D NM**.

USING THE TIMER/TEMP KEY

Press the **TIMER/TEMP** key to cycle through the following options:

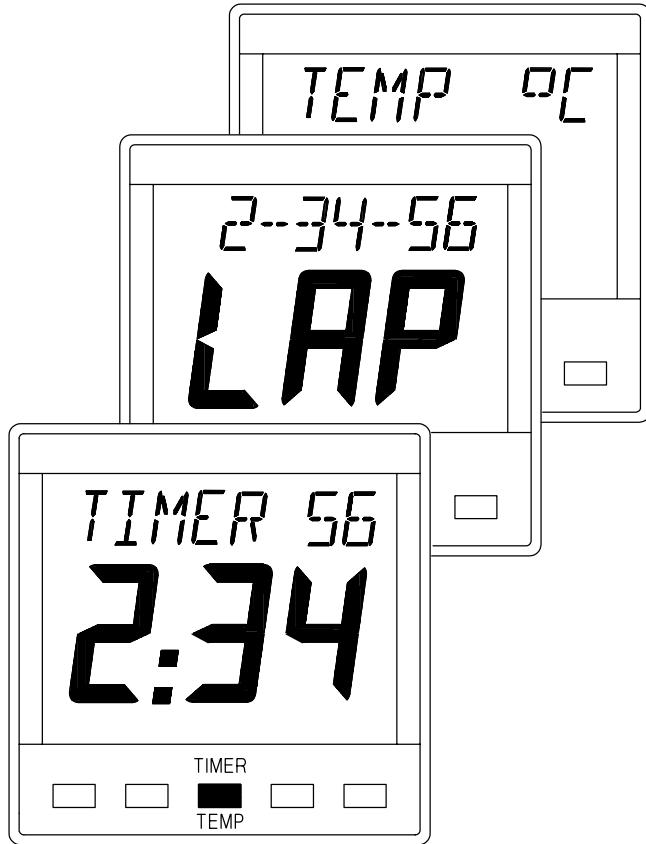

• **TIMER** There are three timers available:

1. 10 minute count-down
2. 5 minute count-down
3. Count-up starting from zero.

All the timers count in one second intervals up to 99 hours, 59 minutes and 59 seconds. When a count-down timer reaches zero it will begin to count up.

• **LAP** This is a Lap Time facility that will freeze the displayed time while the timer remains counting. It can be used with all timers.

• **TEMP °C** The Sea Temperature displayed in degrees Celsius °C or degrees Fahrenheit °F.

SETTING THE TIMERS AND LAP TIMER

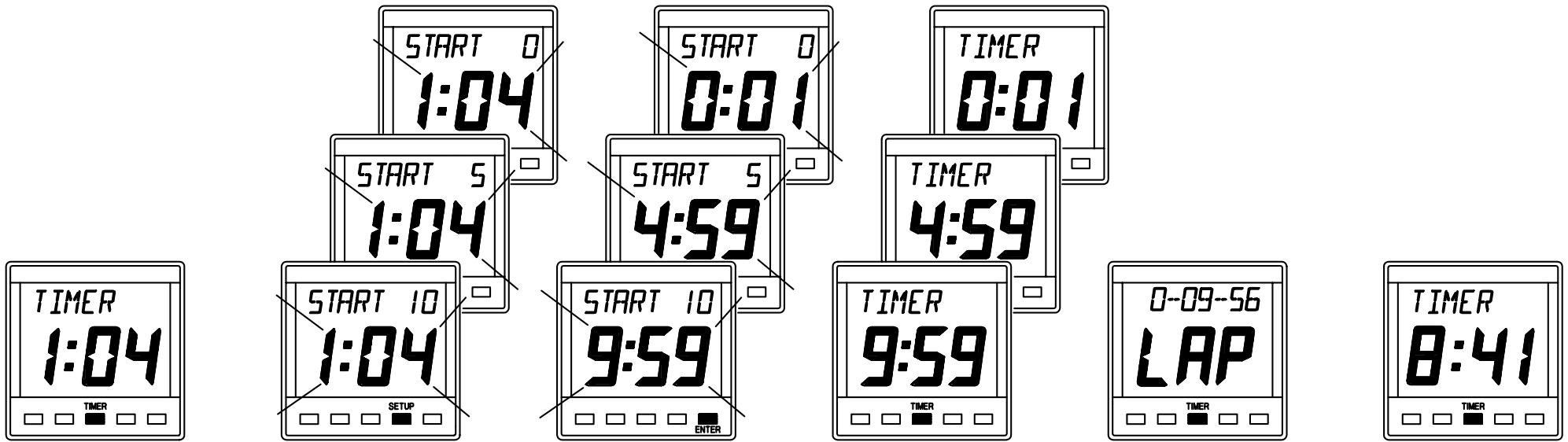

Press the **TIMER** key to display the timers.

Press **SETUP** key,
 1 10 minute
 2 5 minute
 3 Count-up
 The display will flash.

Press **ENTER** key, the display is set to the selected starting value. The timer starts to count.

Press **TIMER** key, the display stops flashing and the timer is running.

Press **TIMER** key to freeze the timer, the display shows **LAP**.

Press **TIMER** key twice to resume the timer selected.

SETTING THE TEMPERATURE UNITS

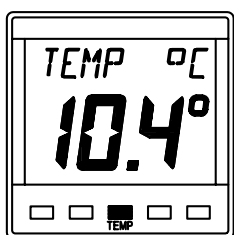

Press **TEMP** key until **TEMP °C** is displayed.

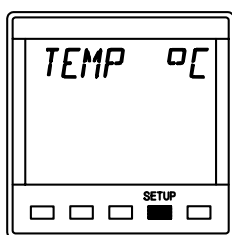

Press **SETUP** key once to display the current units.

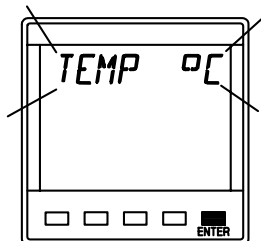

Press **ENTER** if the units are to be changed. The display will flash.

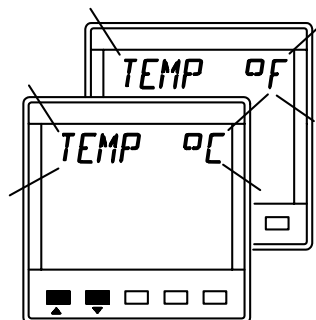

Use **▲** or **▼** keys to change the displayed units.

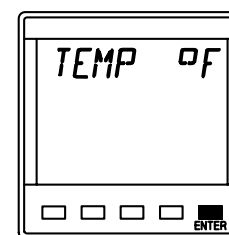

Press **ENTER** key to memorise the new units.

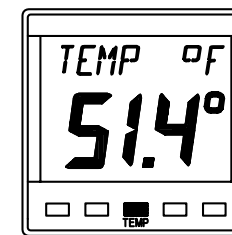

Press **TEMP** key to display sea temperature

CALIBRATING THE TEMPERATURE SENSOR

Temperature calibration should only be carried out when the built-in seawater temperature sensor (part of the speed sensor) is considered to be inaccurate. The temperature of the water will have to be measured with an accurate temperature-sensing device; this value can then be entered into the Network SPEED unit.

In the following example the unit is displaying a reading of 10.4°C, the water temperature is known to be 11.4°C. The correct value is entered into the Network SPEED unit.

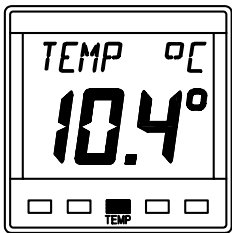

Press **TEMP** key until **TEMP °C** is displayed.

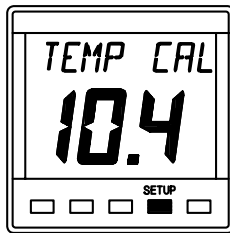

Press **SETUP** key twice to display **TEMP CAL**.

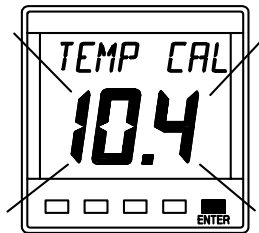

Press **ENTER** if to change. The display will flash.

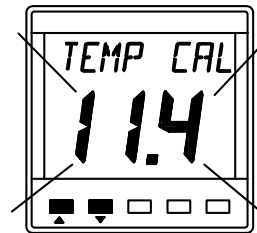

Use **▲** or **▼** keys to change the displayed units.

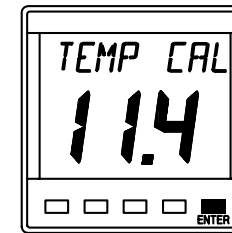

Press **ENTER** key to memorise the new units.

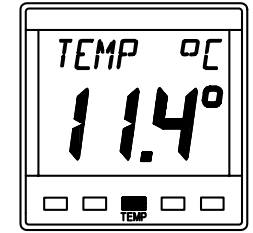

Press **TEMP** key to display sea temperature.

USING THE LIGHTS KEY

The Network SPEED Display unit has 3 levels of illumination and off, controlled by the **LIGHTS** key. The level selected is for the whole Network system.

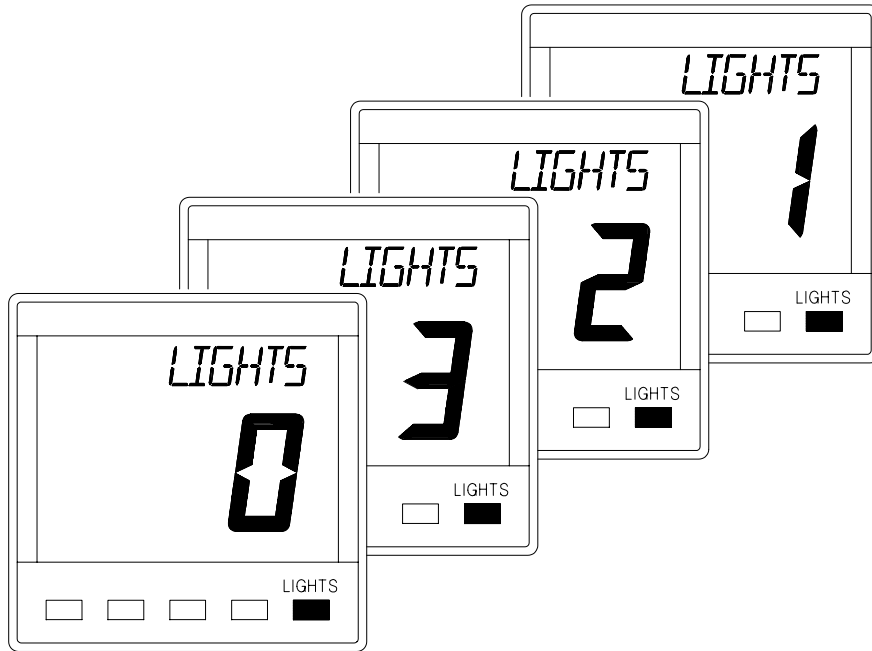

- **LIGHTS 0** OFF
- **LIGHTS 3** High
- **LIGHTS 2** Medium
- **LIGHTS 1** Low

The **LIGHTS** key also changes the illumination level of the key legends; it always remains illuminated so even in complete darkness the key can be located.

NETWORK ALARMS

The Network SPEED unit has an internal buzzer that will sound when an alarm condition is met on a Network unit that has alarm functions ie. Network DEPTH and Network QUAD for depth alarms and Network PILOT for Watch Alarm and Off Course alarms. The unit will also display which alarm is activated.

To silence the internal alarm and return the display to normal operation press any of the five keys.

DEPTH ALARM DISPLAY

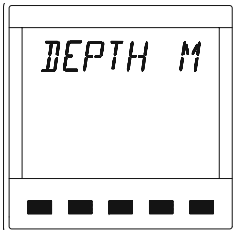

Depth alarms can be set for the following:

- Shallow water
- Deep water
- Anchor Watch
- Check your Network DEPTH or QUAD unit to see which alarm is activated.

NETWORK PILOT ALARM DISPLAYS

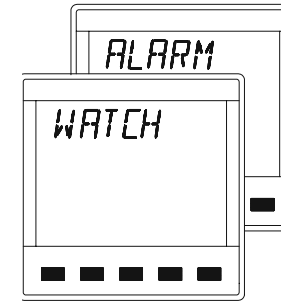

The Watch Alarm is a count-down timer with is activated at the end of the preset count-down period. The display alternates between the messages above.

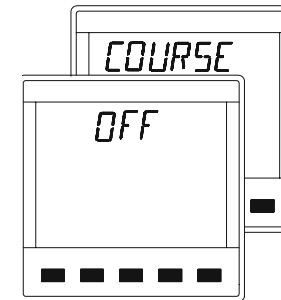

The Off Course alarm is activated when the boat deviates off course by a preset amount. The display alternates between the messages above.

FAULT AND ERROR MESSAGES

NETWORK PILOT FAULT DISPLAY

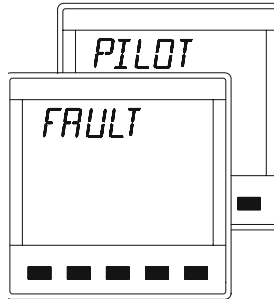

If Network PILOT should have a fault the autopilot computer unit will send a message to all other Network Display Units. The Network SPEED unit will alternately display the follow message, the actual fault will have to read from the Network PILOT Display unit.

UNIT INTERNAL ERRORS

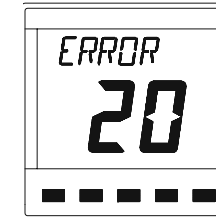

In the unlikely event that your Network SPEED unit should develop an internal error, the unit will sound it's alarm continuously and the display will show an error number. Pressing the keys will not silence this alarm.

In some cases the fault can be cleared by switching off the instruments at the supply, waiting a few moments and then switching on again. If this does not clear the fault the error number should be recorded.

Switch off the supply and disconnect the faulty unit. Return it with the error number to your dealer for servicing.

INSTALLATIONINSTALLATIONINSTALLATION

The display heads are supplied with a clip-in mounting bracket which allows for easy installation, access from behind is not necessary to secure the unit in place. However to prevent theft and permanently fix the unit in position, locking studs and thumb nuts are supplied.

SITING THE UNIT SITING THE UNIT SITING THE UNIT

All Network Instruments are designed for mounting on or below deck. A mounting position should be selected where they are:

- Easy to read by the helmsman
- On a smooth and flat surface
- At least 100mm (4") from a compass
- Accessible from behind for fitting locking studs if required.

MOUNTING THE UNIT

Use the cutting template supplied to mark the centres of the holes for the self-tapping screw, the fixing stud holes and the mounting bracket.

- The template allows 4mm (5/32") between adjacent units for the suncover, increase this distance if required to maximum of 60mm (2 3/8") between units or 180mm (3 1/8") between centres. For greater distances between units extension cables are available.
- Use a 70mm (2 3/4") diameter hole-cutter for the mounting bracket hole.
- Use a 2.9mm for the self-tapping screw holes.
- Use a 5mm (3/32") drill for the locking stud holes.
- Secure the mounting bracket to the bulkhead with the self-tapping screws supplied
- Fit the rubber sealing gasket around the mounting bracket.
- Screw the locking studs into the back of the display head (if required).
- Carefully pass the cable tails through the mounting bracket hole, connect the cables to the main units.
- Clip the display head into the mounting bracket.
- Secure the instrument with the thumb nuts supplied.

INSTALLATION DETAILS

Front View of Unit

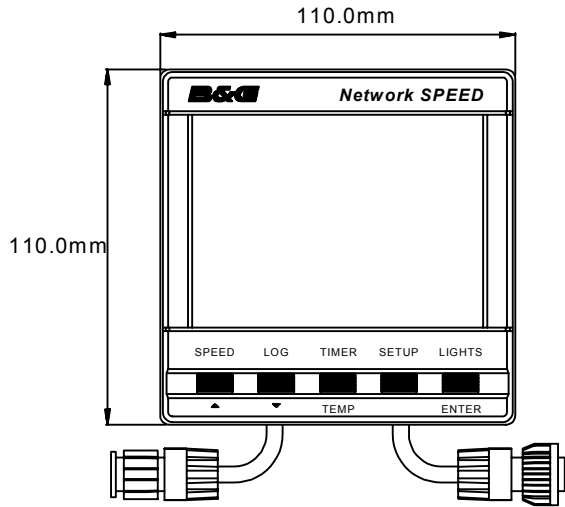

Side View of Unit

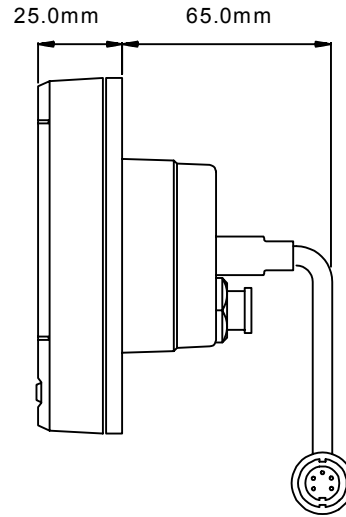

Rear View of Unit

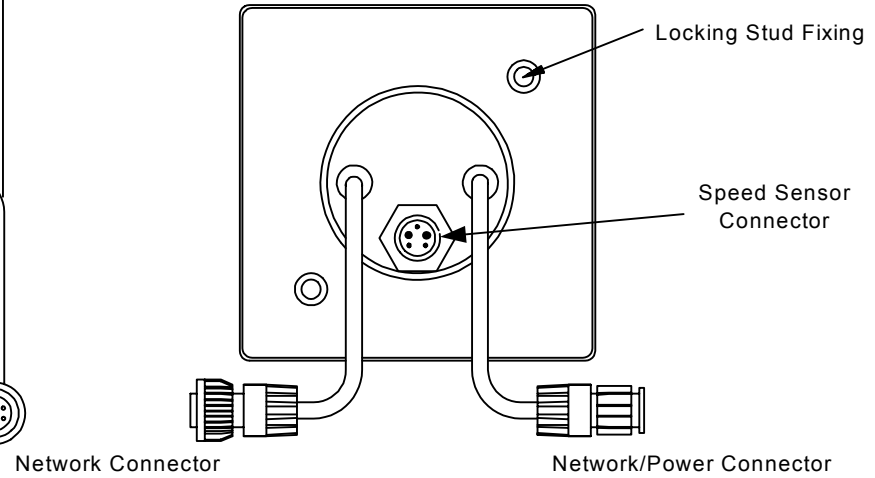

Mounting Bracket

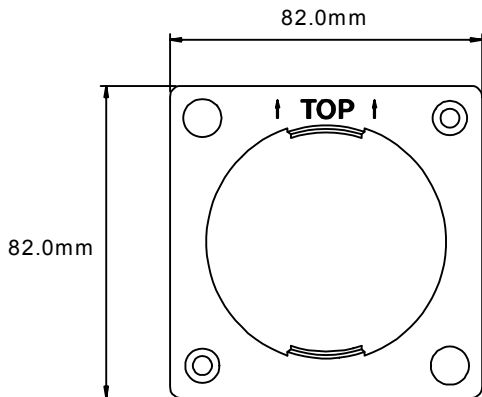

Rubber Gasket

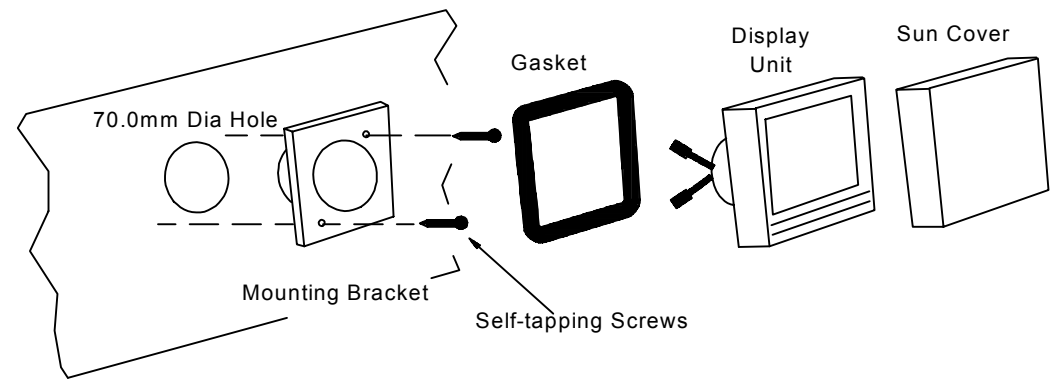
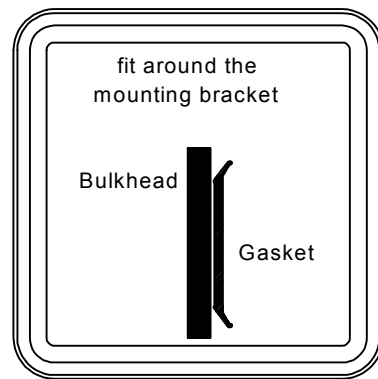

SPECIFICATIONS

PHYSICAL PARAMETERS

Construction	High impact ABS plastic
Window	Acrylic
Display	Back-lit Liquid Crystal Display: Large Digits: 28.6mm 1.12" Small Digits: 11.5mm 0.45"
Dimensions	110 x 110 x 25.4mm 4 x 4 x 1" Requires 65mm 2.6" depth behind bulkhead for display barrel
Weight	0.3 kg 0.66lbs

ENVIRONMENTAL

Operating Temp	-10 to +55°C @ 93%RH +14 to +131°F @ 93%RH
Storage Temp	-25 to +70°C @ 95%RH -13 to +158°F @ 93%RH
Humidity	Up to 95%RH
Sealing	Fully sealed front, suitable for bulkhead cockpit mounting. Vented barrel to prevent condensation.

ELECTRICAL

Power Supply	12V DC nominal (10 to 16V)
Operating Current	40mA typical, 100mA illuminated
Protection	Connect via external 5A fuse or circuit breaker.

CABLES AND CONNECTIONS

Connection to adjacent units is via cable tails fitted with either a plug or a socket. Extension cables are available from your dealer. The cable tails carry power and NMEA data between units.

ALARM

Internal audible alarm

NMEA OUTPUT SENTENCES

\$IIHDM	Heading
\$IIVHW	Speed and Heading
\$IIDBT	Depth
\$IIVWR	Apparent wind angle and speed
\$IIIMTW	Sea temperature