

The FOCUS WINDWATCH multifunction unit utilises the latest technology in electronic design and manufacture to allow simple operation by means of the ROTO-SELECT DIAL (1).

The available functions are selected by using the ROTO-SELECT DIAL (1) and are displayed in the upper section of the display (4).

The apparent wind speed is always displayed in the lower section of the display (3).

The battery alarm is activated if the supply drops to 10 volts or less. This occurs irrespective of any alarm setting.

A full description of the functions available, and their operation, is given in the remainder of this handbook.

Also included are the installation details.

NOTE: True wind functions require a boat speed input. (See installation sheet).

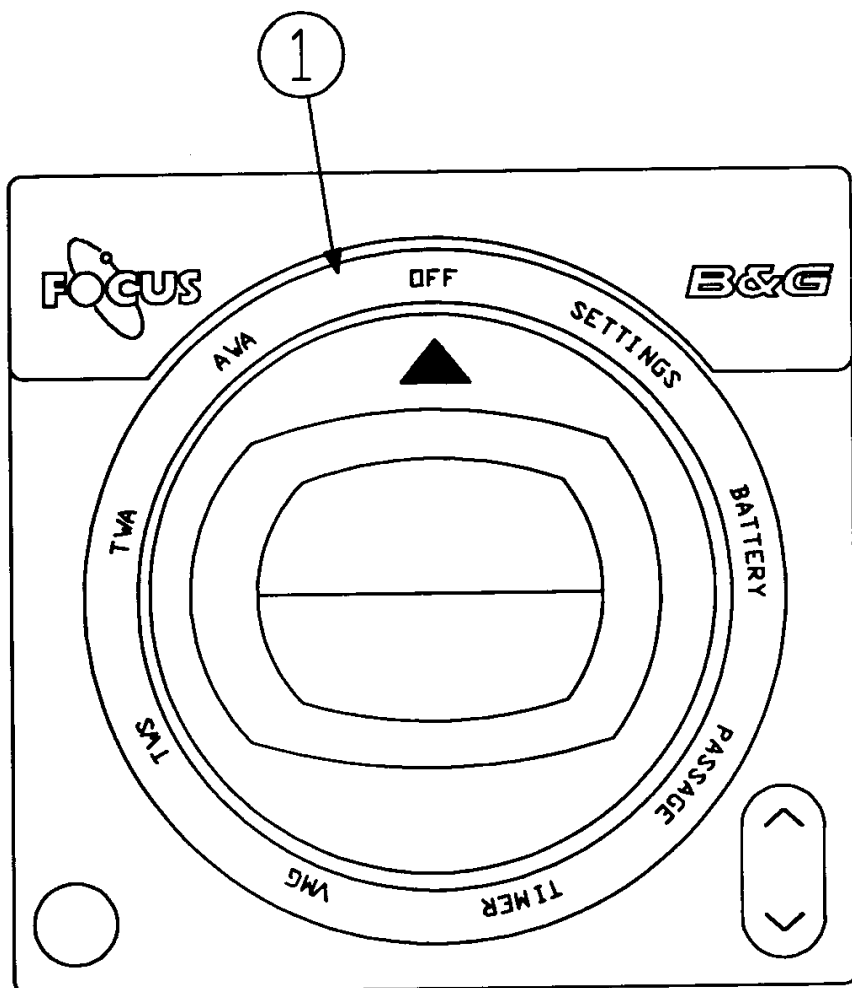

OFF

When the ROTO-SELECT DIAL is set to OFF, WINDWATCH is in a "sleep" mode. Under these conditions the digital display is turned off. However, the alarm values and settings are retained in the memory for future recall.

WINDWATCH will remain inactive until the ROTO-SELECT DIAL (1) is moved from the OFF position.

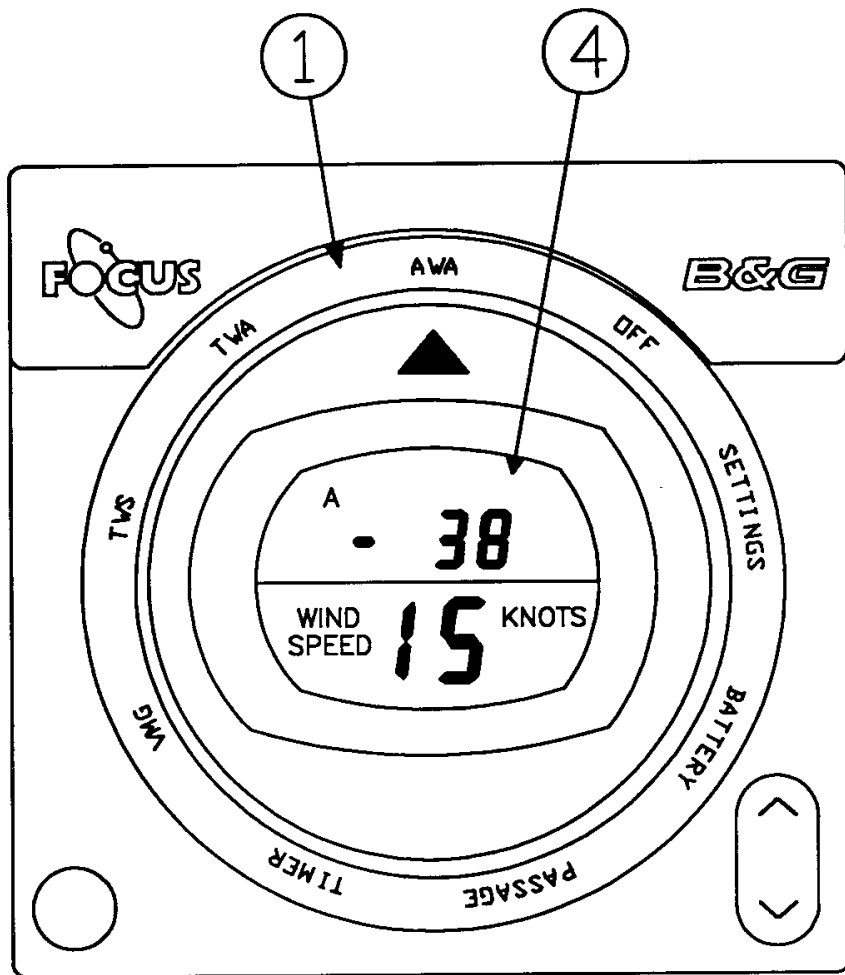

AWA

With the ROTO-SELECT DIAL (1) positioned to "AWA" the Apparent Wind Angle is displayed (4)

Note: The angle is relative to ship's heading.

See SETTINGS (P.21 to 22) for Damping etc.

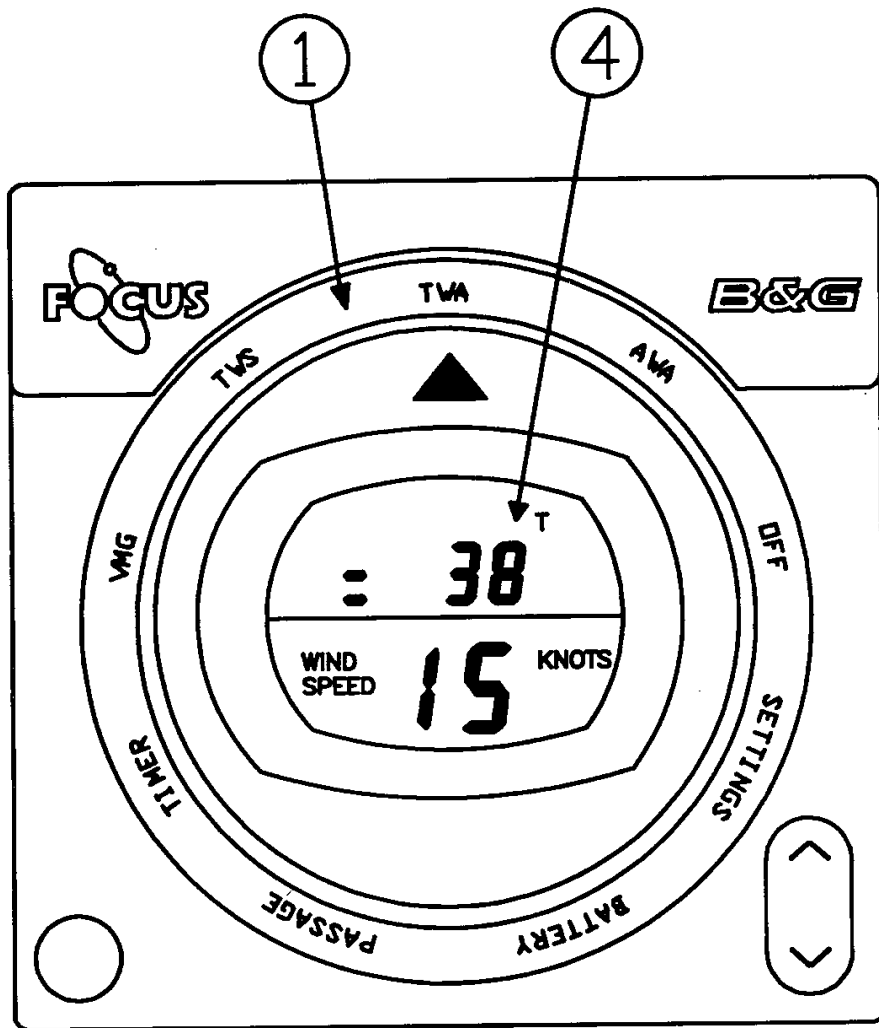

TWA

With the ROTO-SELECT DIAL (1) positioned to "TWA" the True Wind Angle is displayed (4).

Note : The angle is relative to ship's heading

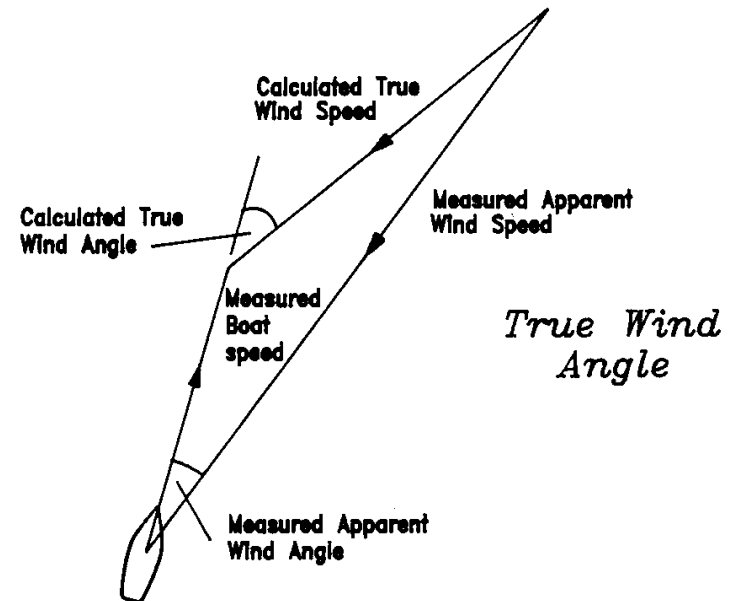

See SETTINGS (P.21 to 22) for Damping etc.

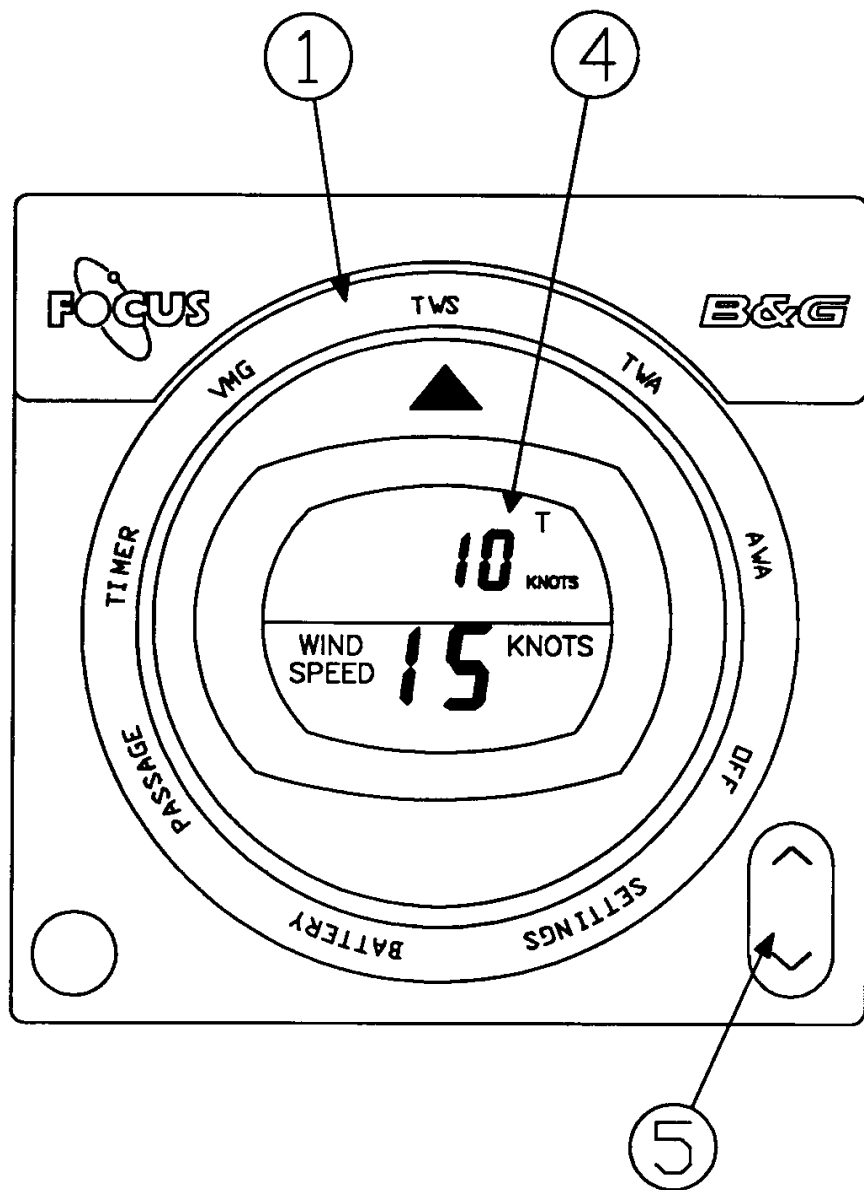

TWS

With the ROTO-SELECT DIAL (1) positioned to "TWS" the True Wind Speed is displayed (4).

The true wind speed may be displayed in knots, miles per hour, metres per second or on the beaufort scale.

- Press the upper part of button 5 to change the wind speed units according to the diagram below:

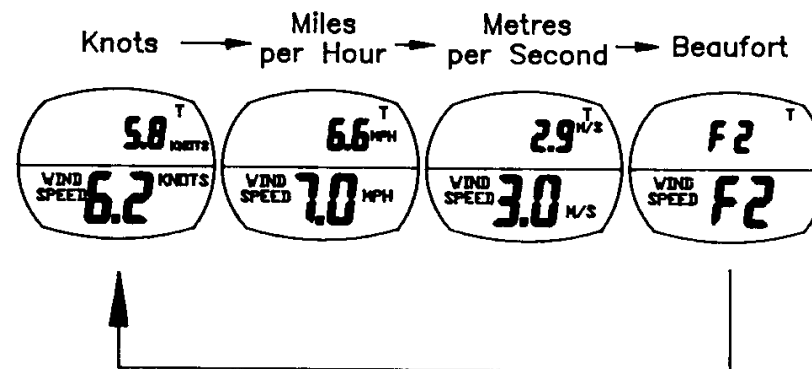

See SETTINGS (P.21 to 22) for Damping etc.

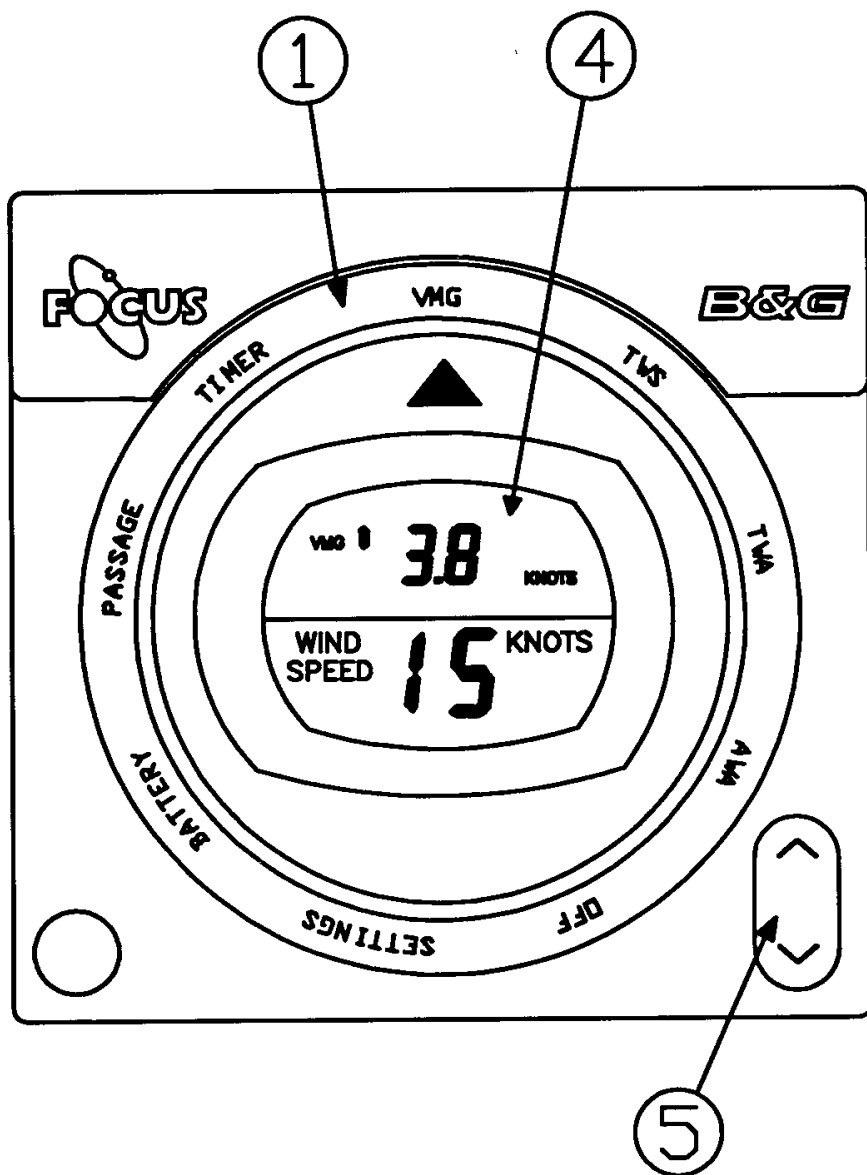

VMG

With the ROTO-SELECT DIAL (1) positioned to "VMG" the Velocity Made Good to windward will be displayed (4).

The bar to the left of the digits indicates whether VMG is rising or falling. (No bar indicates no change in VMG).

- Press the upper part of button 5 to change the VMG units. Knots, MPH or M/S may be selected.

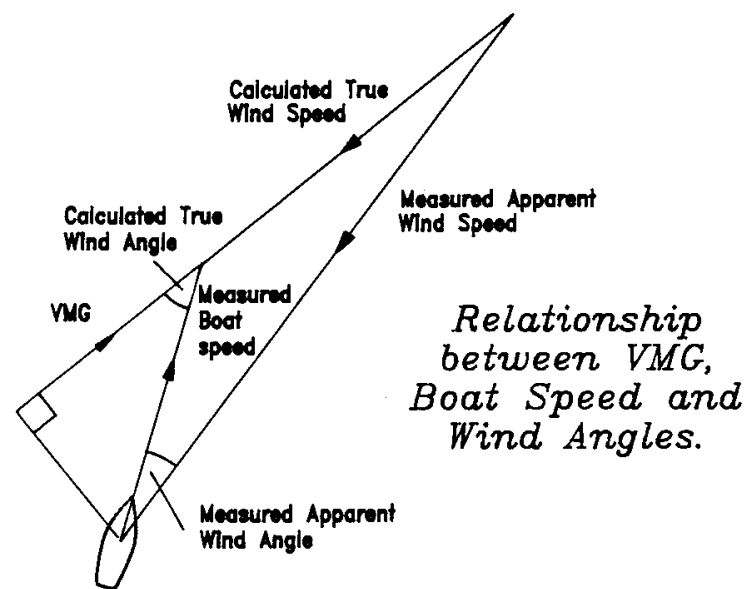

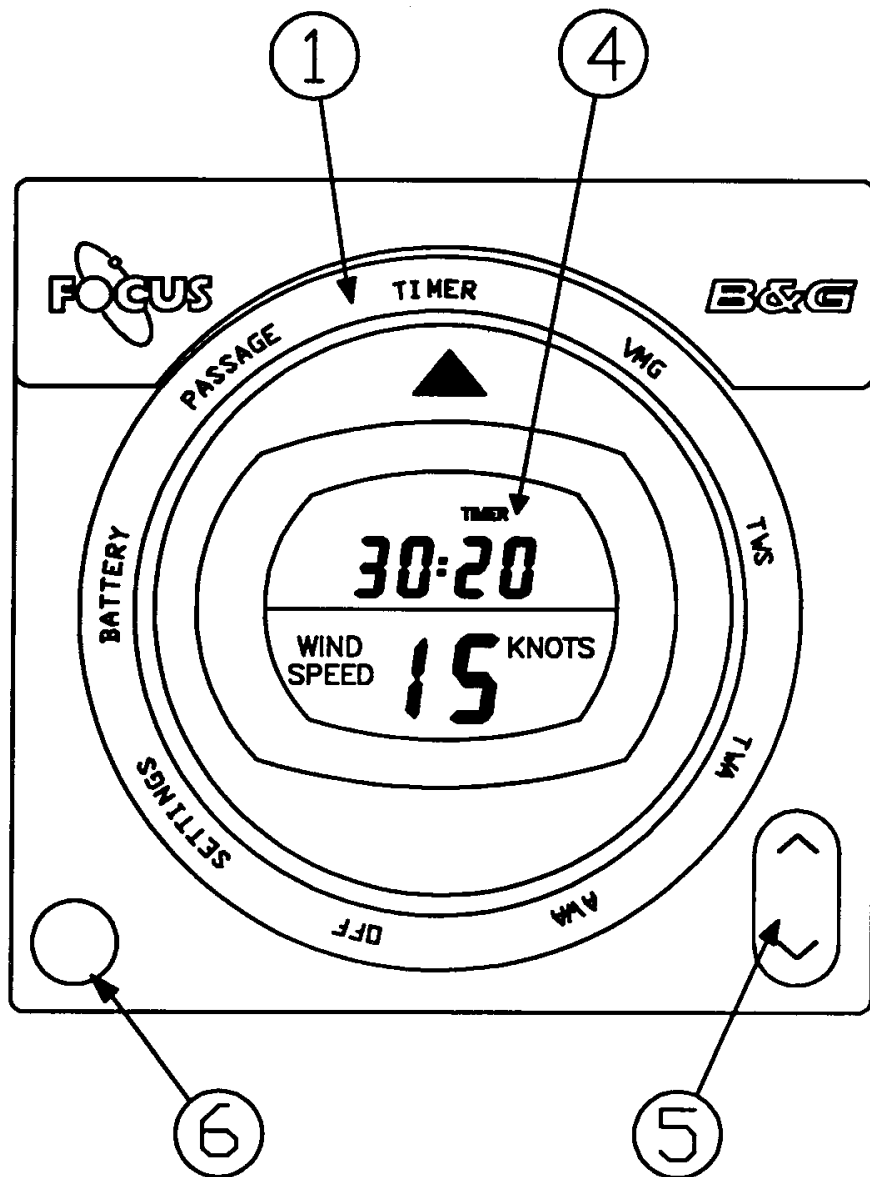

TIMER

With the ROTO-SELECT DIAL (1) positioned to "TIMER" the Timer is displayed (4)

DISPLAY FORMAT

The timer value may be displayed in an hour/min or min/sec format. With the timer running in hour/min format, the colon will flash.

- Use the upper part of button 5 to change the format at any time.

COUNTDOWN/STOPWATCH

The countdown/stopwatch facility allows the timer to be reset to one of the preset values and then started. The reset values range from -60 min to zero in 5 min steps. When the countdown reaches zero, the timer automatically begins counting up. The timer will run for 24 hours, after which time it restarts from zero.

- With timer running, press 6 to stop the timer.
- Use the lower part of button 5 to select reset value.
- Press 6 to start timer running.
- To stop the timer, if required, press 6.

TIMER (Continued)

SPLIT TIME

With the timer running, the display may be frozen (giving split time) to allow the timer value to be noted. The TIMER legend will flash to indicate that the display is showing split time.

- With timer running, press lower part of button 5 to give split time.
- Press lower part of button 5 to return to normal running mode.

LAP TIME

At the end of each leg or lap the timer can be restarted from zero.

- With timer running, press lower part of button 5. This gives split time.
- Press 6 to restart timer from previous key press.

The diagram opposite illustrates the operation of the timer.

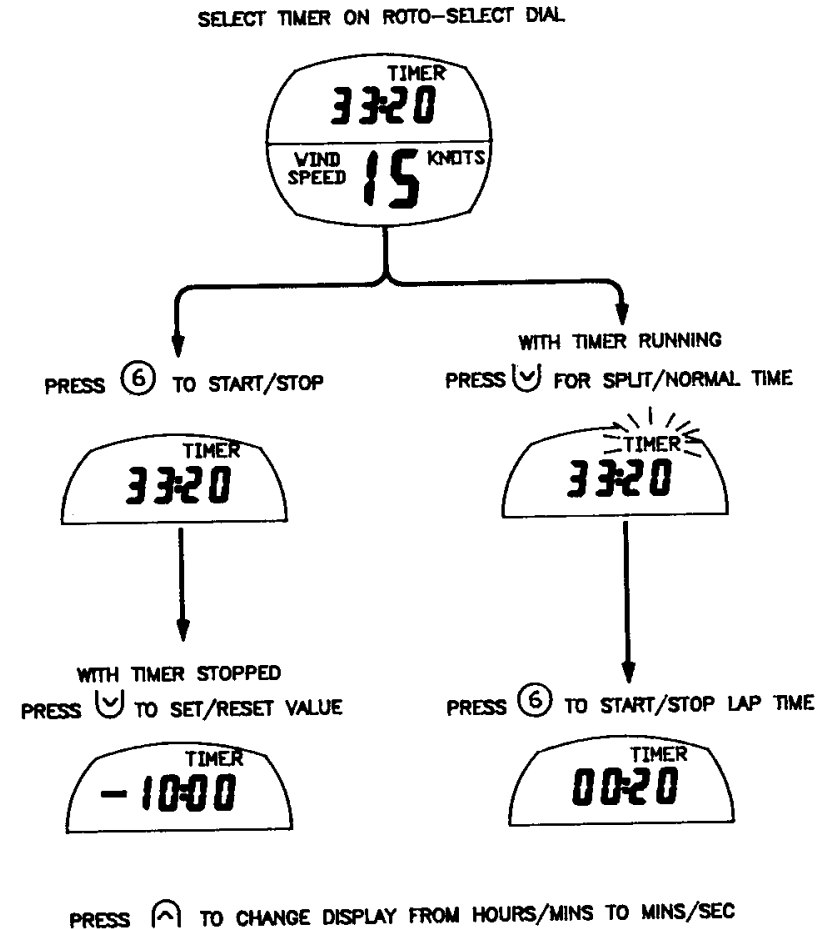

PASSAGE

With the ROTO-SELECT DIAL (1) positioned to "PASSAGE" the Passage Timer is displayed (4).

DISPLAY FORMAT

The Passage Timer value may be displayed in an hour/min or min/sec format. Whilst running in hour/min format, the colon will flash.

STOPWATCH

The Passage Timer may be reset to zero and then started. This Timer will run for 100 hours after which time it restarts from zero.

SPLIT TIME

With the Passage Timer running, the display may be frozen (giving split time) to allow the timer value to be noted. The **PASSAGE TIMER** legend will flash to indicate that the display is showing split time.

- Refer to timer diagram for operation detail.

The Passage Timer may be "triggered" to restart from zero, when the Countdown Timer passes through, or is started from zero (see Settings P.21). If the trigger is on, "On" appears in the display when viewing Passage Timer.

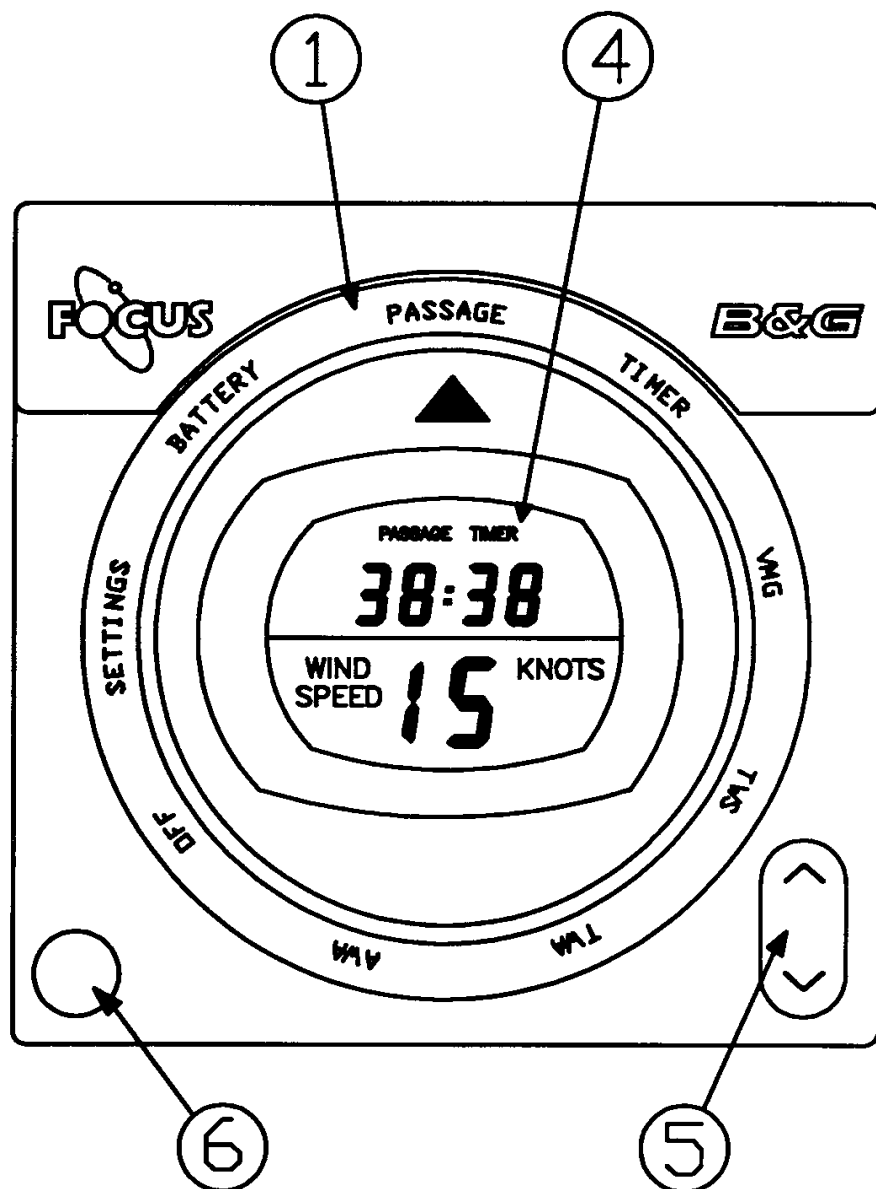

BATTERY

With the ROTO-SELECT DIAL (1) positioned to BATTERY the Battery volts will be displayed (4).

WINDWATCH includes a battery volts alarm. This features a flashing battery symbol (and optional buzzer) indicating low battery voltage.

- Press button 6 to change between battery volts and the alarm value.
- Use button 5 to change the alarm value.

The alarm facility can be "switched" on and off (see SETTINGS P.21) If the alarm is on, the word SET will appear when viewing the alarm value.

- To "Silence" the alarm press button 6. The battery symbol will remain on until the voltage rises above the alarm value.

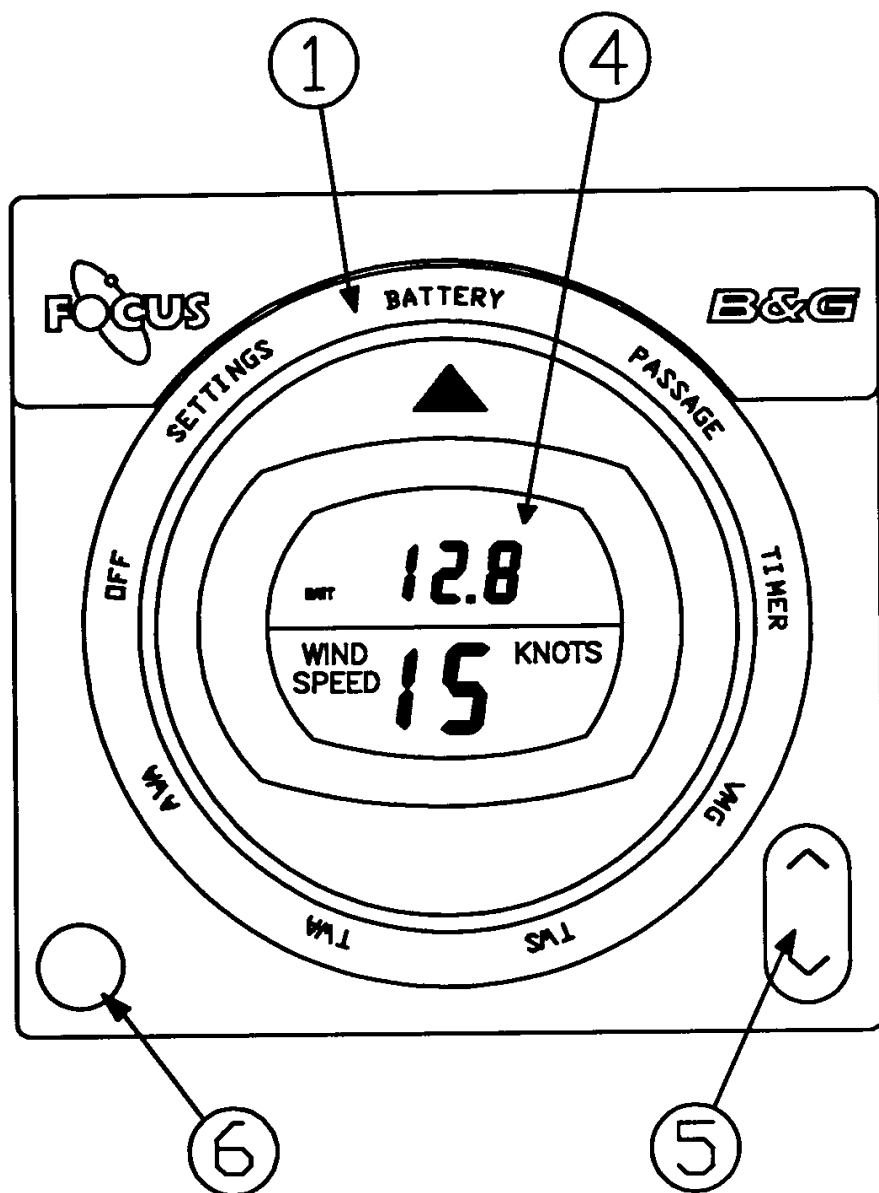

BATTERY VOLTS

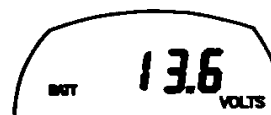

ALARM VALUE
(Alarm is ON)

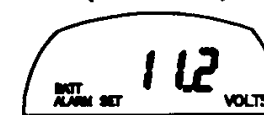

The alarm will activate, irrespective of the above, should the supply drop to 10 volts.

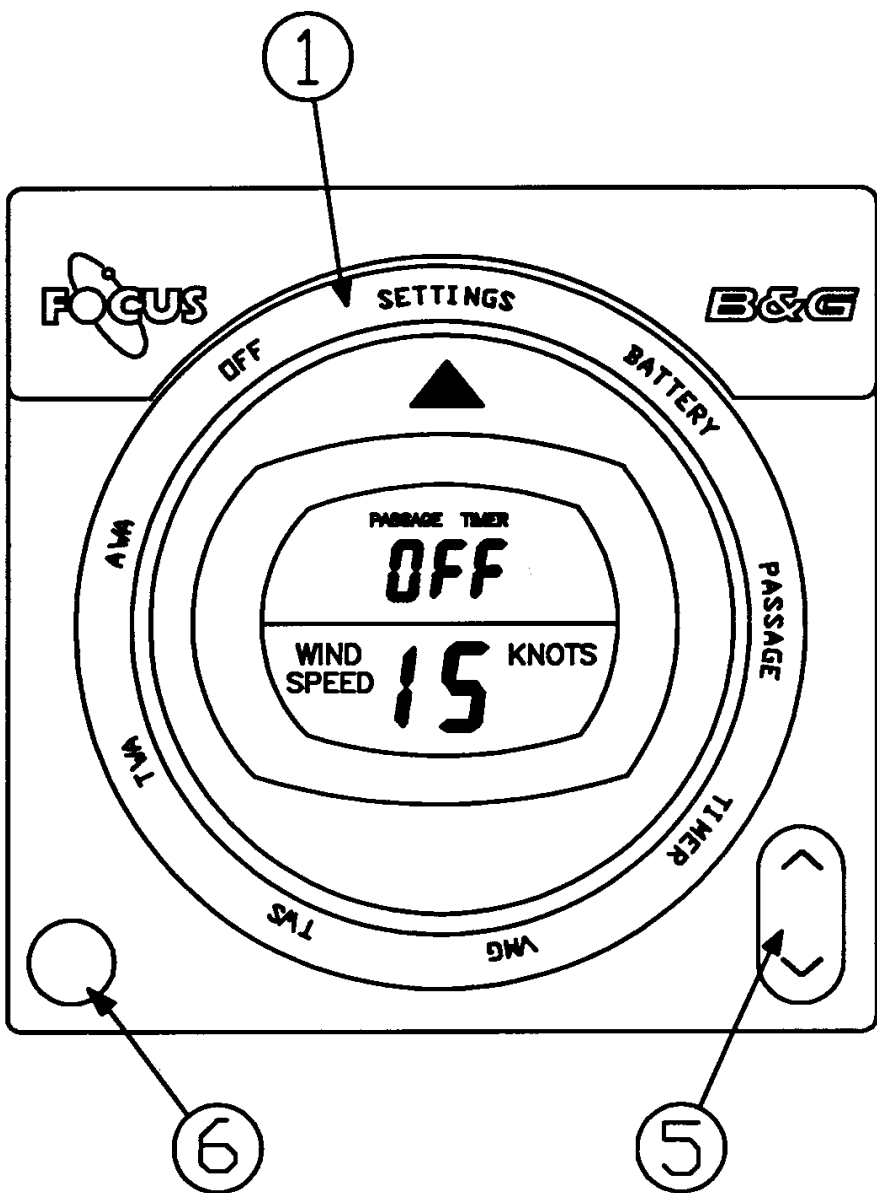

SETTINGS

With the ROTO-SELECT DIAL (1) positioned to "SETTINGS" the calibration, damping values, etc. may be adjusted.

The first option to appear is the Passage Timer Trigger.



- Use button 5 to switch Trigger on/off. (When on, it triggers the Passage Timer to start with the Countdown Timer).

- Press 6 to select the Damping option.



- Use button 5 to adjust the damping value for the calculation of the digital functions.

- Press 6 to select the Pointer Damping option.



- This option is not used in the current Focus Windwatch version.

SETTINGS (Continued)

- Press 6 to select the Battery Alarm Switch option.



- Use button 5 to switch the battery volts alarm facility on/off.

- Press 6 to select the MHU Alignment Setting option.



- Use button 5 to adjust the MHU Alignment value. (See Assessing Masthead Unit Alignment).

- Press 6 to select the Log Cal option.



- Use button 5 to adjust the Log Calibration factor to equal the Log Cal factor shown on the FOCUS SPEEDSOUNDER.

- Press 6 to select the Wind Angle Display format option.



- Use button 5 to select either the +/- 180 degree format or the 0 - 360 degree format for displaying wind angles.

22.

ASSESSING MASTHEAD UNIT ALIGNMENT

For accurate wind angle readings, the Masthead Unit (MHU) should be correctly aligned with the centreline of the vessel. However, Windwatch is able to compensate for MHU alignment error.

The MHU alignment may be ascertained as follows:-

1. Select AWA and sail close hauled to windward. When conditions are steady note the AWA reading and the extent to which the sails are sheeted in.
2. Tack the vessel and sheet in as for the opposite tack and note AWA as before.
3. Repeat steps 1 and 2 several times to obtain average AWA for each tack. If these Port and Starboard values differ then the MHU is misaligned. Divide the difference by two to give the indicated MHU alignment value.
4. Enter the MHU alignment value into the Windwatch memory by selecting option 5 under "SETTINGS".

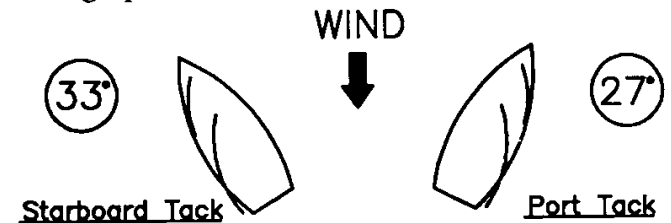

Difference between AWA tack to tack = 6°
Indicated MHU Offset = 3°

If Port Tack low : SUBTRACT 3° from MHU alignment setting
If Starboard Tack low: ADD 3° to MHU alignment setting

FITTING THE WINDWATCH DISPLAY UNIT

Select a suitable position on the required bulkhead, position typically preferred is shown.

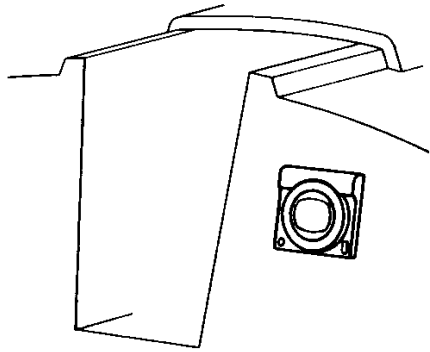

Fitting the WINDWATCH Display unit:

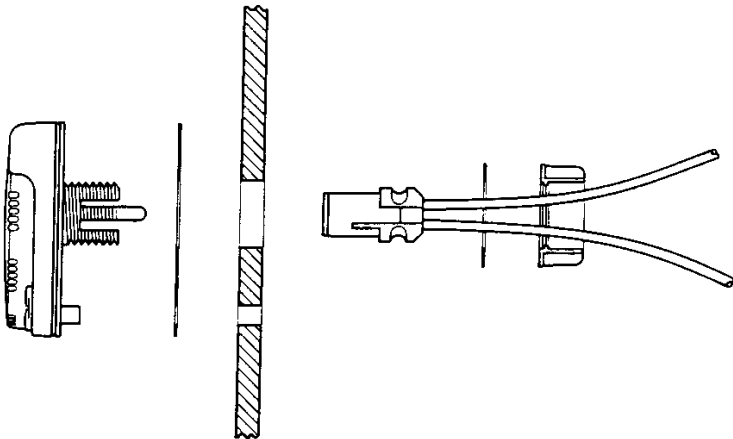

1. Site the Display unit in the required place ensuring there will be 60mm (2.5") clearance between the front of the mounting panel and any inside bulkhead.
2. Stick the template to the display area and drill the 38mm (1.5") and 10mm (3/8") hole in the display bulkhead.
3. Run the Service Cable from the display panel (leaving the plug half hanging out of the larger of the two display mounting holes) to the power source:
 - i) Connect the power wires:
Red wire to Battery +ve and Black and Blue wires to Battery -ve.
 - ii) Connect the lighting wires:
Yellow to Lighting +ve and White to Lighting -ve.
 - iii) If an Alarm is required, connect the Brown wire to the Alarm -ve and connect a wire from Battery +ve to Alarm +ve.

iv) The green wire is connected to the Focus Speed-sounder, providing the log information required to obtain the calculated wind functions.

4. Feed the Sensor Cable with the connector to the back of the Display mounting bulkhead and out of the larger display mounting holes next to the plug half and Service Cable.

5. Assemble the two plug halves using the two screws provided, as shown in the diagram.

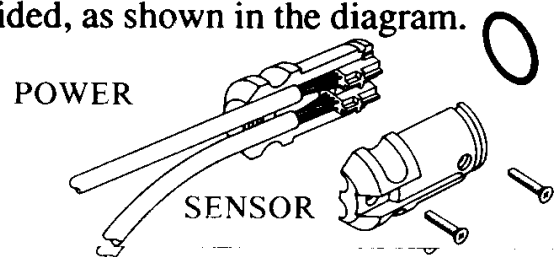

6. Withdraw plug into bulkhead and slide display fixing nut and rubber washer over plug assembly.

7. Push WINDWATCH Display Unit, with large rubber seal, into holes. Push the Plug into the back of the unit until the tabs engage the plug cutouts and screw up the nut until hand tight. Do not use wrench or spanners.

8. Remove Yellow Protective film over display window. The unit is now ready for use.

INSTALLATION DETAILS

For FOCUS WINDWATCH installation details see separate Drawing Number 210-IS-0368-03.

For interconnections with FOCUS SPEEDSOUNDER see separate Drawing Number 210-IS-0344-02.

GENERAL

WINDWATCH contains a battery backed memory, retaining the choice of units and calibration factors. This ensures the retention of all data even when disconnected from a power supply. The life expectancy of the battery is between 5 and 10 years.

If the information for Log calibration and Mast Head offsets etc. are lost it is recommended that the unit is returned to an authorised B&G agent for battery replacement.

- Lighting** The illumination for the instrument is by the yellow and white wires of the Service cable. Standard 5V "T 3/4 Longlife" lamps are used. The lifetime is expected to be 5 to 10 years (if not subjected to over volt conditions). The bulbs should only be replaced by an authorised B&G dealer as this involves removing the rear cover.
- Alarm** A 12 volt (.4 amp max) Alarm Buzzer can be fitted, see installation diagrams. This is an open collector type drive, therefore FOCUS SPEEDSOUNDER and WINDWATCH and repeaters can use the same alarm.
- Mounting** When mounting the display unit ensure the correct holes are made (see installation details) and the rear mounting gaskets are fitted on each side of the bulk head.
- Water resistance** The display units are designed for mounting in a cockpit. The unit utilises micro-climatic control; this ensures best operation under any condition.
- Cleaning** Do not clean the display or the mast head unit with solvents. Use only soapy warm (not hot) water. The ROTO-SELECT DIAL can be removed for cleaning; salt build up may cause sticking. Take care not to lose the spring and ratchet when removing the bezel.